

iberica pultrusionados

C A T A L O G O 2020

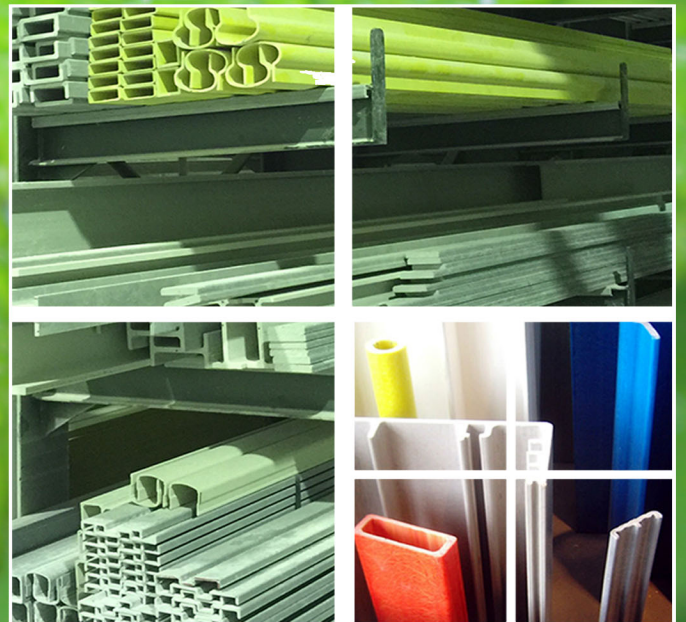
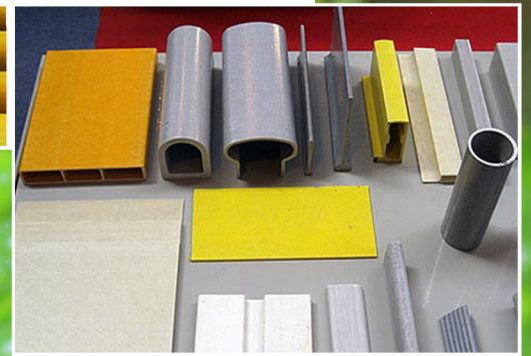
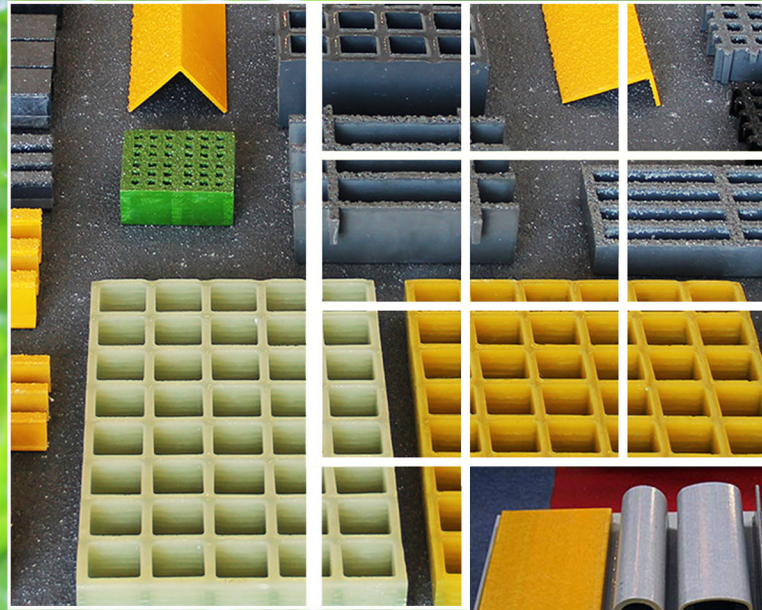

Escaleras
Verticales

Escaleras Verticales



Escaleras Verticales

Escaleras Verticales

Somos de los fabricantes europeos más competitivos en el acceso fijo.

Proyectamos y fabricamos nuestras escaleras y accesorios de acuerdo con las normas de seguridad más estrictas.

En 2011 hemos obtenido la certificación de prueba que nos ha convertido en una de las pocas empresas en el mundo con escaleras PRVF aprobadas.

Tenemos todo tipo de accesorios estándar: Guardas - dorsal; descansillo, extensiones, sistemas contra el acceso ...



ibérica pultrusionados

Fotografías Trabajos

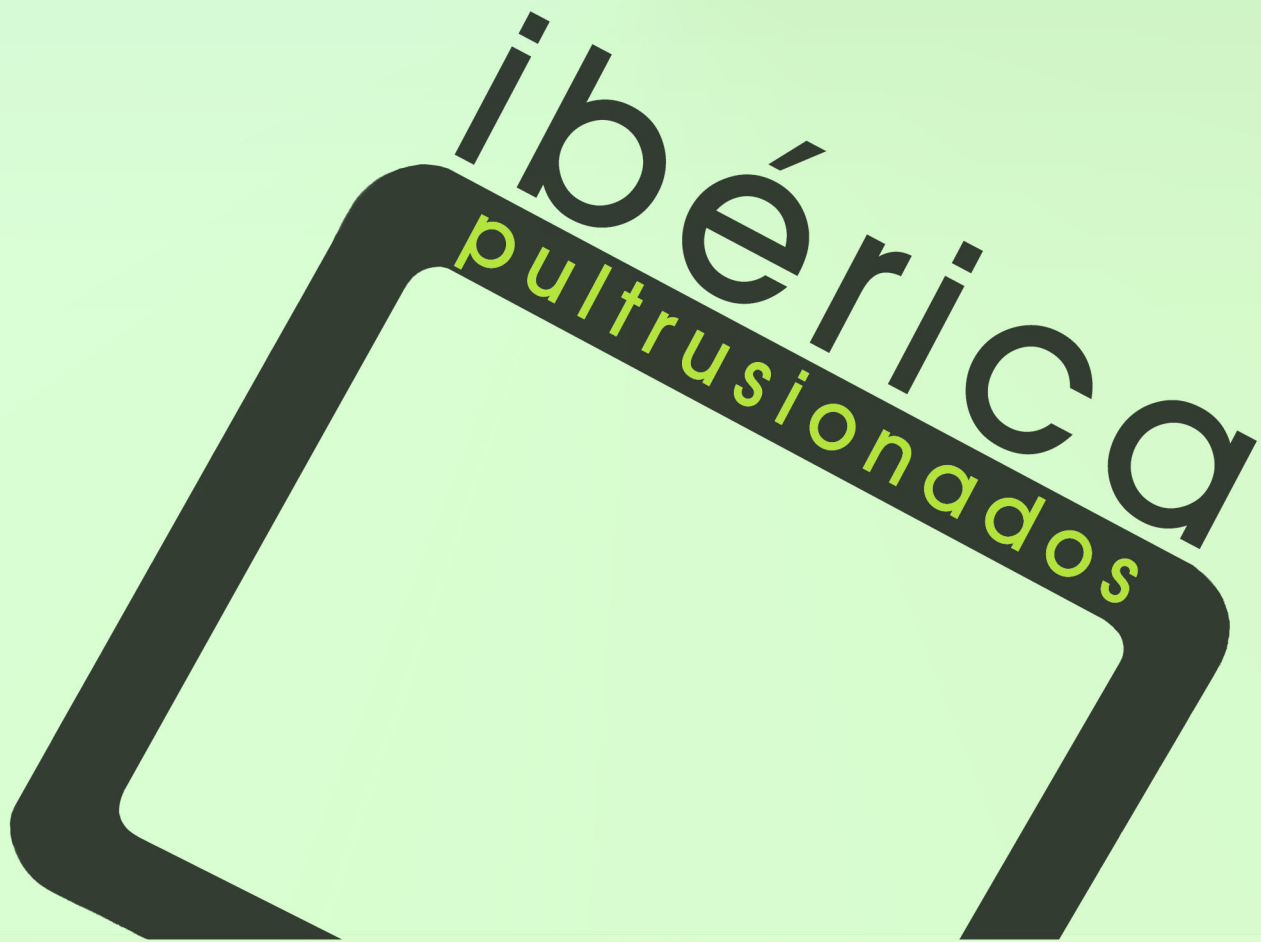

Iberica Pultrusionados@2016 - Direitos Reservados

Travessa do Bairro, nº 50 - Z.I. Aveleda - Armazém B - 4485-010 AVELEDA VDC - Portugal - Tel.: +351 22 9960117 - Fax: +351 22 99668303 - info@iberica-pultrusionados.com - www.iberica-pultrusionados.com

Escaleras Verticales

Escaleras verticales

Diseñamos y fabricamos nuestras escaleras y accesorios de acuerdo con los más estrictos estándares de seguridad.

Desarrollamos cualquier tipo de tapas de escaleras más específicas para proyectos especiales.

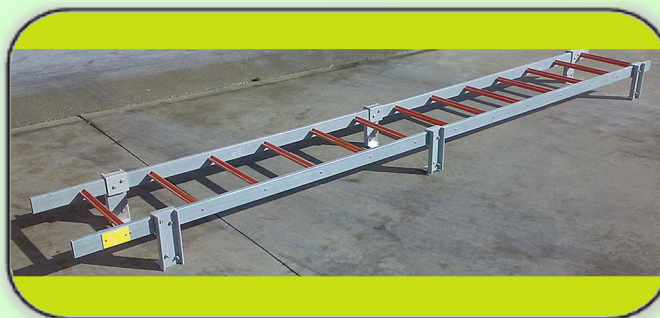
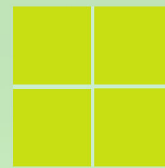
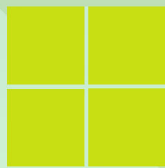

ibérica pultrusionados

Diseño
Técnico

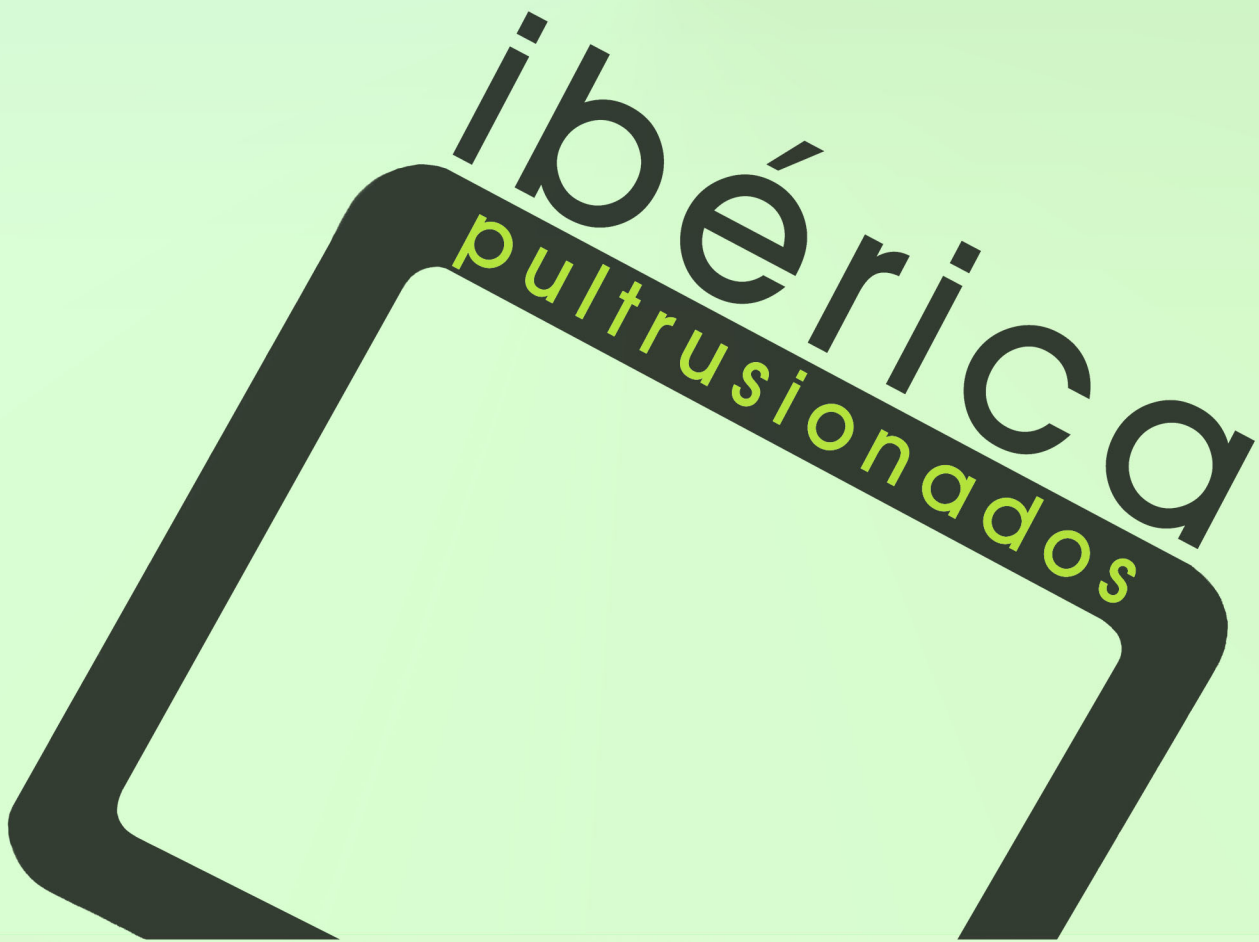

Accesorios y Kits

Tenemos nuestra propia producción de accesorios de montaje, lo que permite una ejecución rápida de proyectos especiales.

Los accesorios de FRP y acero inoxidable están disponibles.

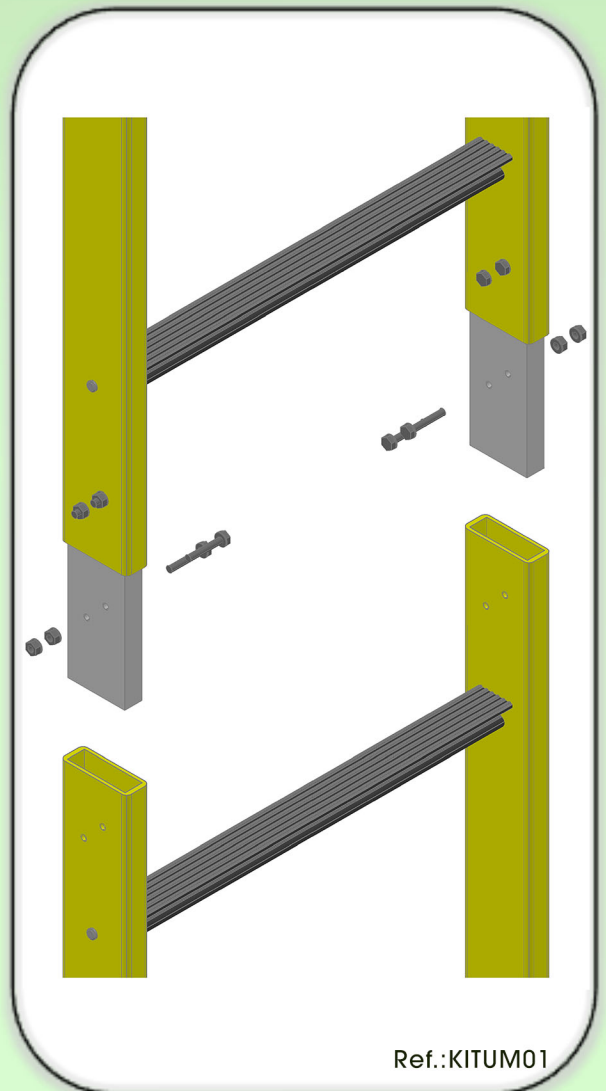
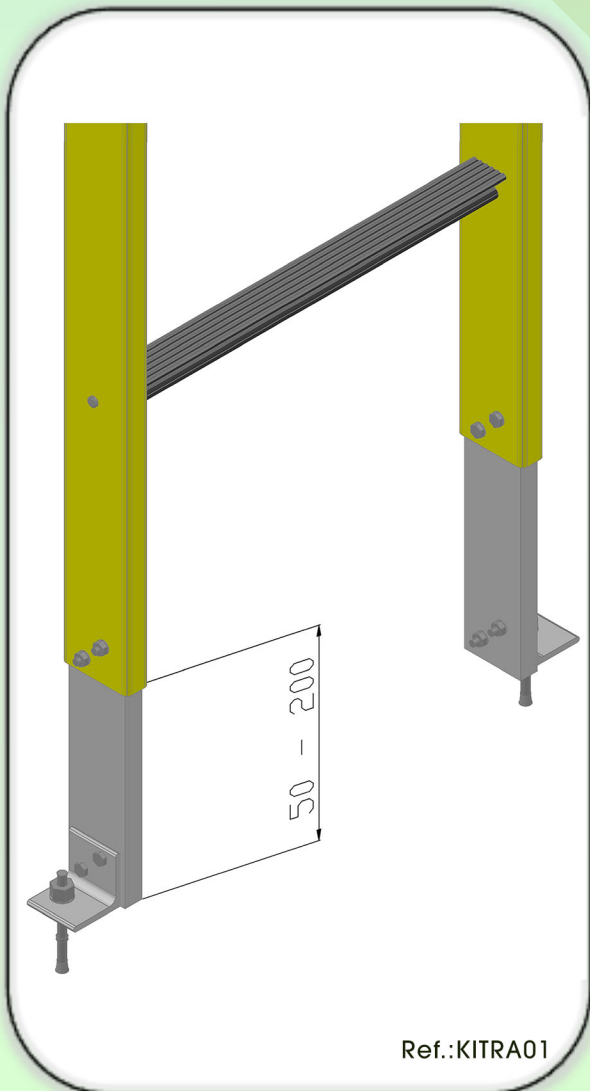
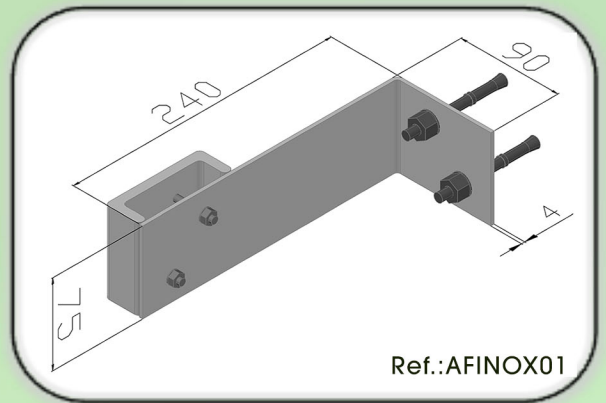
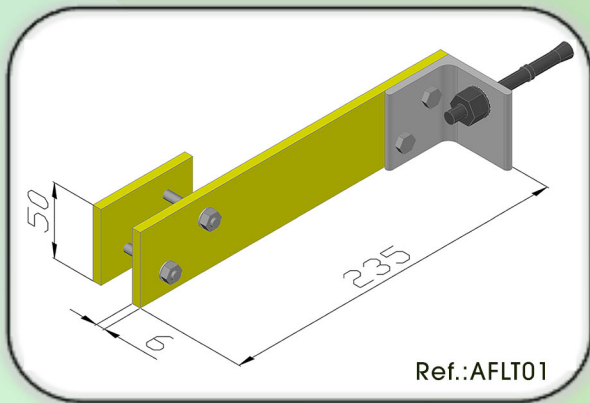

Accesorios y Kits

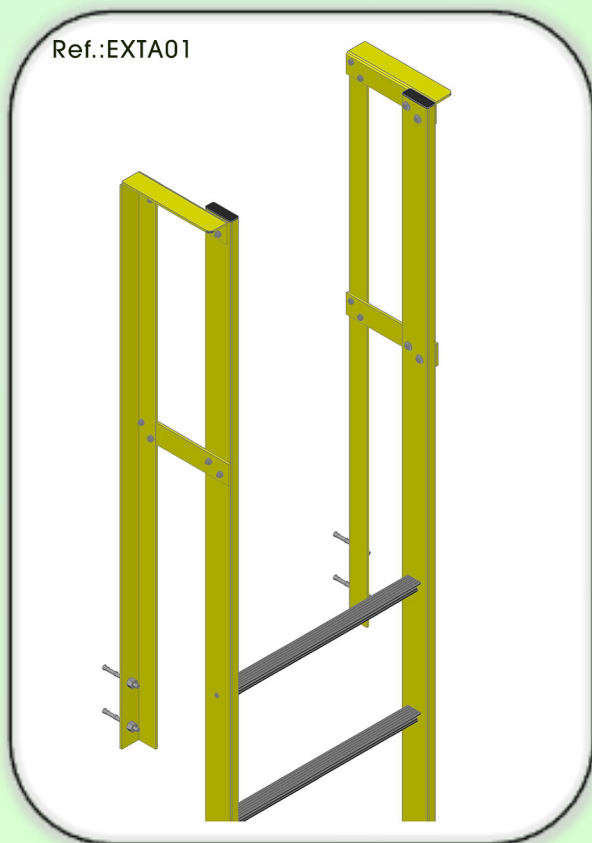
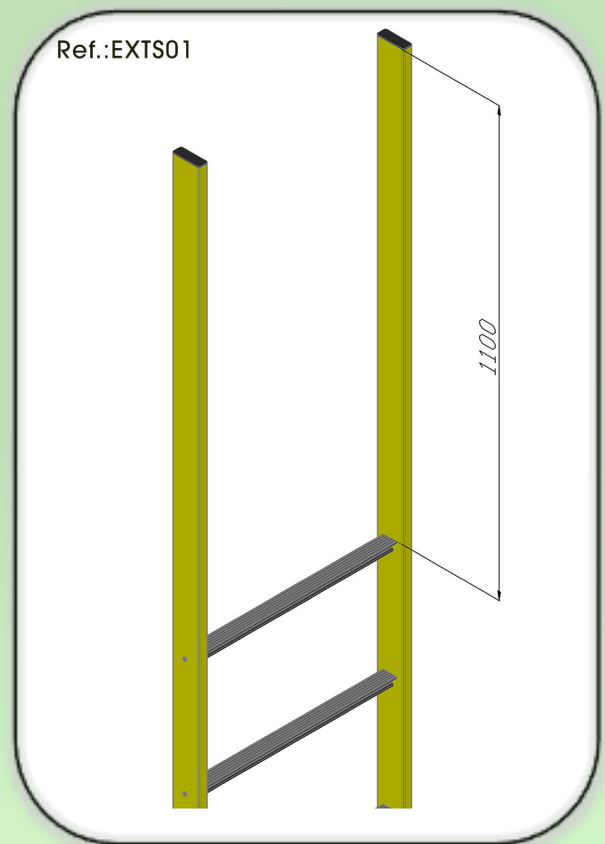
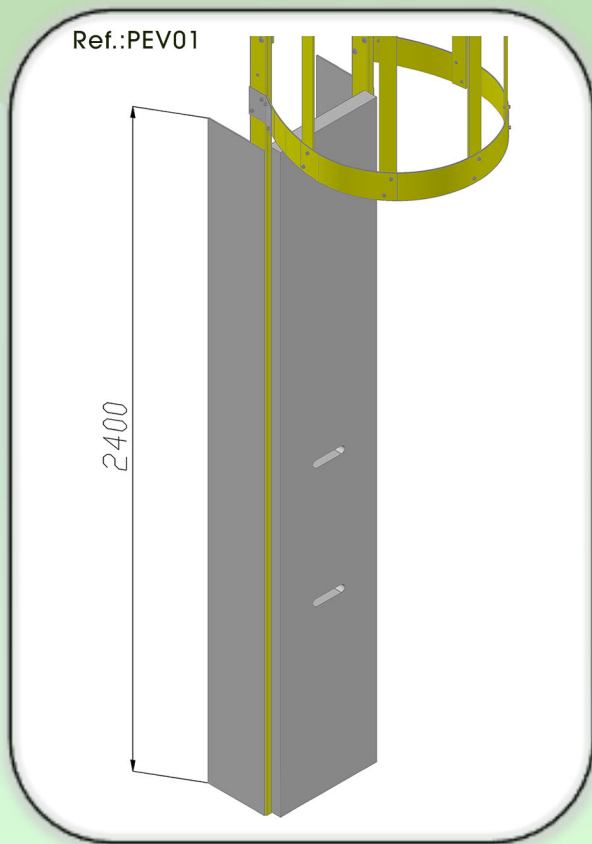

Accesorios y Kits | Escalera vertical

Modelo de escalera vertical EV_IBP_LT: Equipo diseñado y probado para cumplir con ISO 14122-4 y EN131.

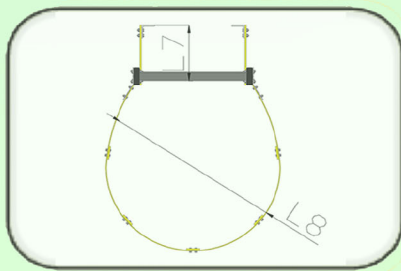
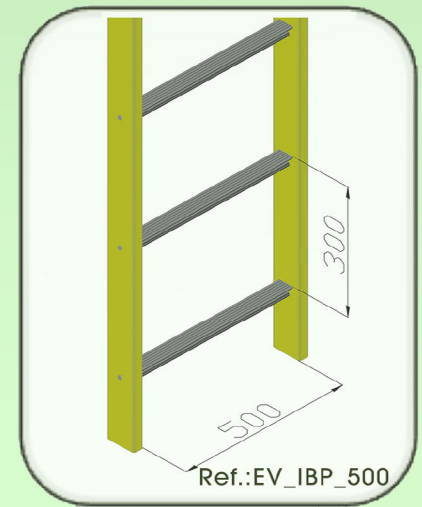
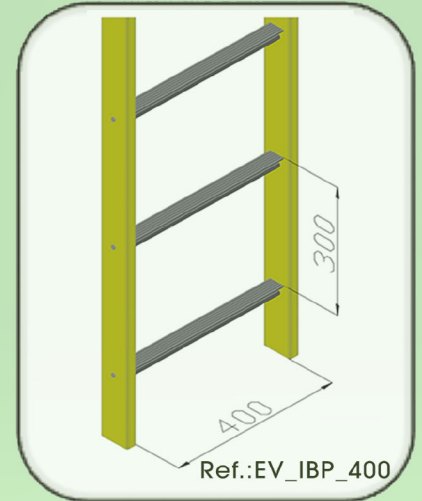
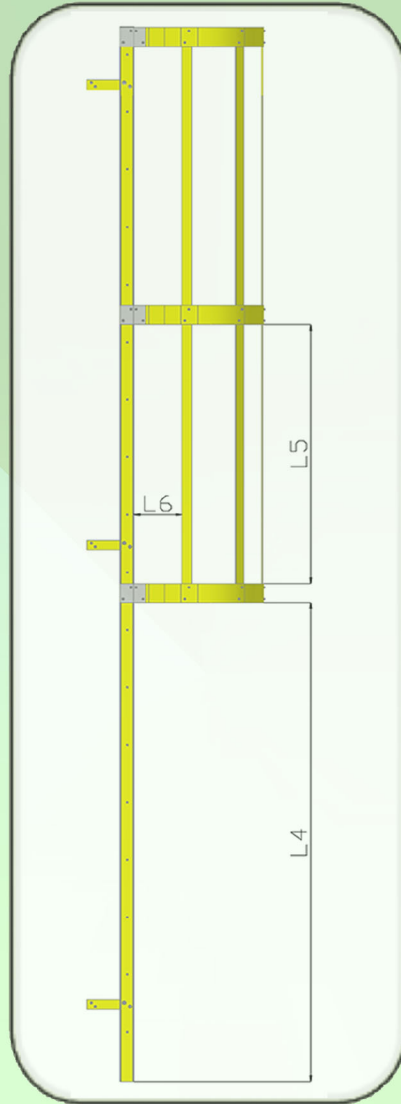
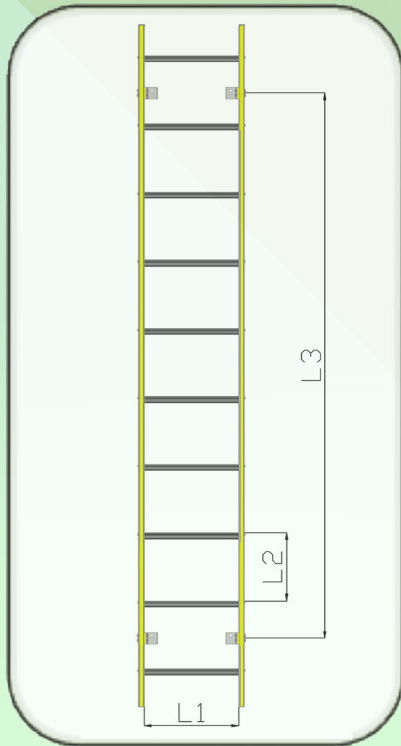

Dim.	Equipo Estándar	Límites Normativos
L 1	400 mm y 500 mm	400 mm → 600 mm
L 2	300 mm	225 mm → 300 mm
L 3	Max = 3000 mm	N / D
L 4	2200 mm → 3000 mm	2200 mm → 3000 mm
L 5	Max = 1500 mm	Max = 1500 mm
L 6	Max = 300 mm	Max = 300 mm
L 7	Min = 200 mm	Min = 200 mm
L 8	650 mm y 750 mm	650 mm → 800 mm

Accesorios y Kits

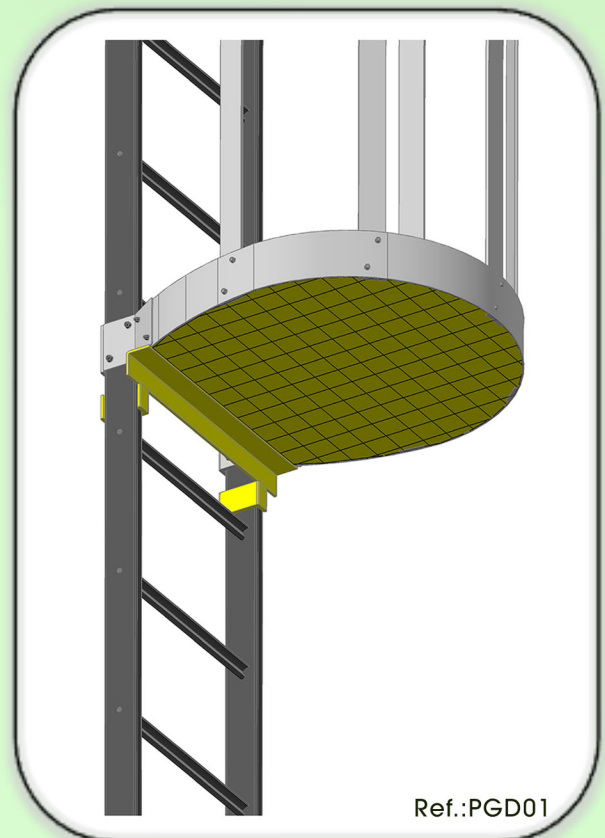
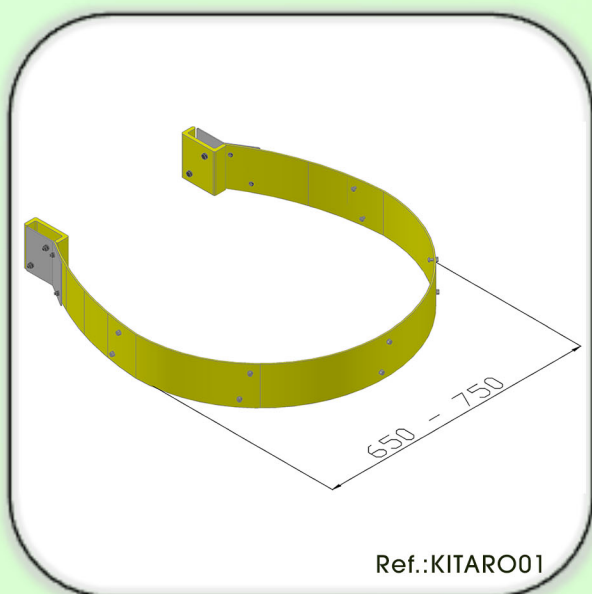
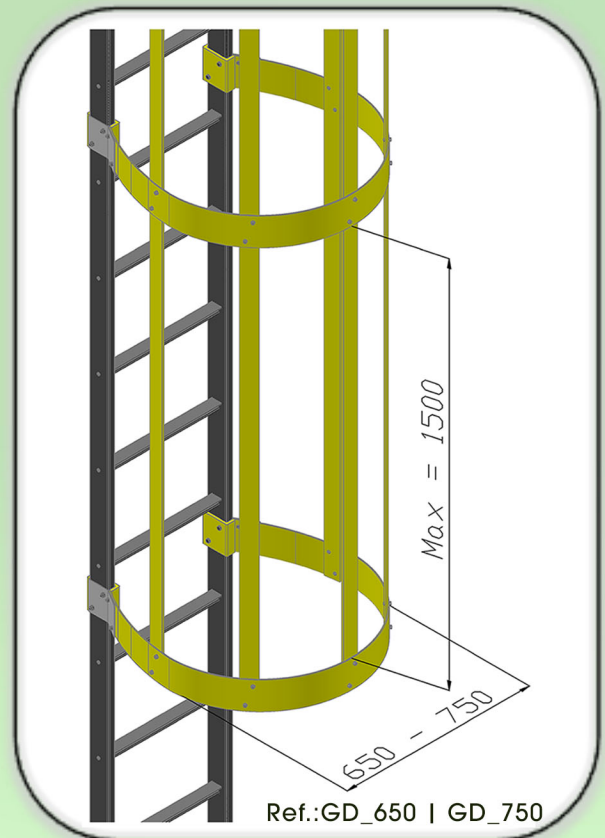

ibérica pultrusionados

