

iberica pultrusionados

C A T Á L O G O 2020

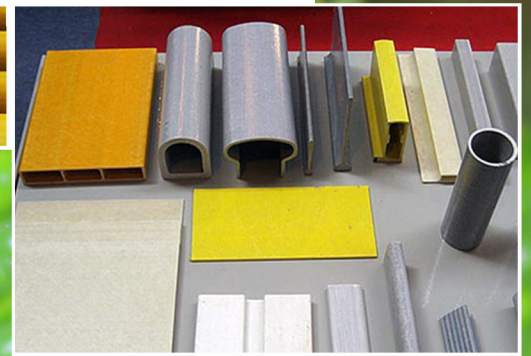
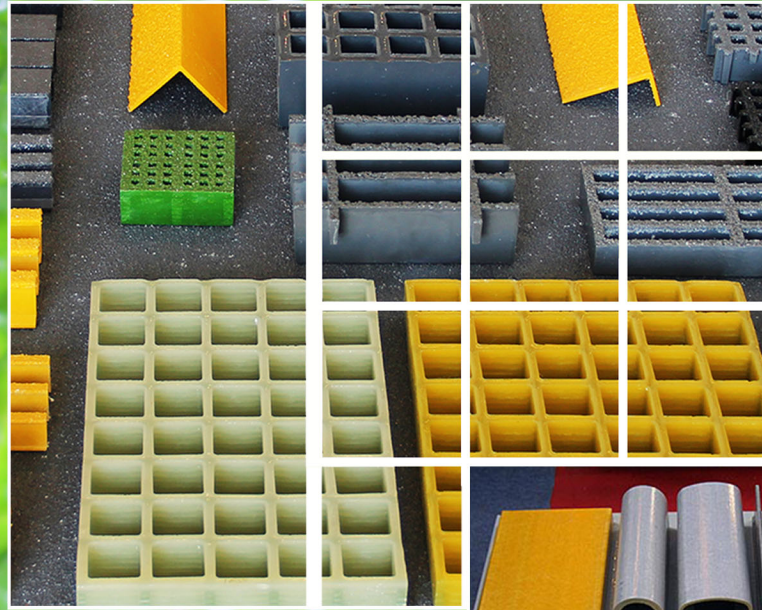

Guarda
Corpos

Guarda corpos



Guarda corpos



Guarda corpos

Projectamos e fabricamos guarda corpos seguros, versáteis e adaptáveis a envolventes industriais ou arquitectónicas.

Temos uma vasta gama de modelos standard e podemos, facilmente, criar modelos específicos à medida dos nossos clientes.

As medidas dos equipamentos encontram-se em conformidade com o tipo de aplicação, normas vigentes ou especificações técnicas.

Desenvolvemos Kits de produtos, com manuais específicos, fáceis de aplicar em obra.

- » Baixo peso
- » Transformação simples
- » Propriedades mecânicas
- » Ecológicos
- » Diminuição dos acidentes de trabalho
- » Relação preço qualidade



ibérica pultrusionados

Fotografias

Obras



Guarda corpos | Corrimões

Guarda corpos | Corrimões

Equipamento composto por perfis ligeiros, desenhado para garantir boas condições de segurança.

Todos os modelos de guarda corpos encontram-se disponíveis na cor cinzenta e amarela. Contudo, podem ser fabricados ou pintados em cores específicas.

Nas utilizações exteriores são aplicadas camadas superficiais de protector UV que impossibilitam, por largos períodos de tempo, o micro desgaste da resina superficial.

Entre as várias potencialidade deste equipamento destacam-se a elevada resistência à corrosão e ataques químicos.

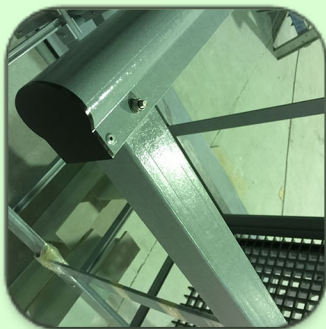
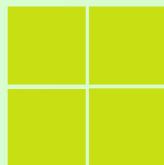
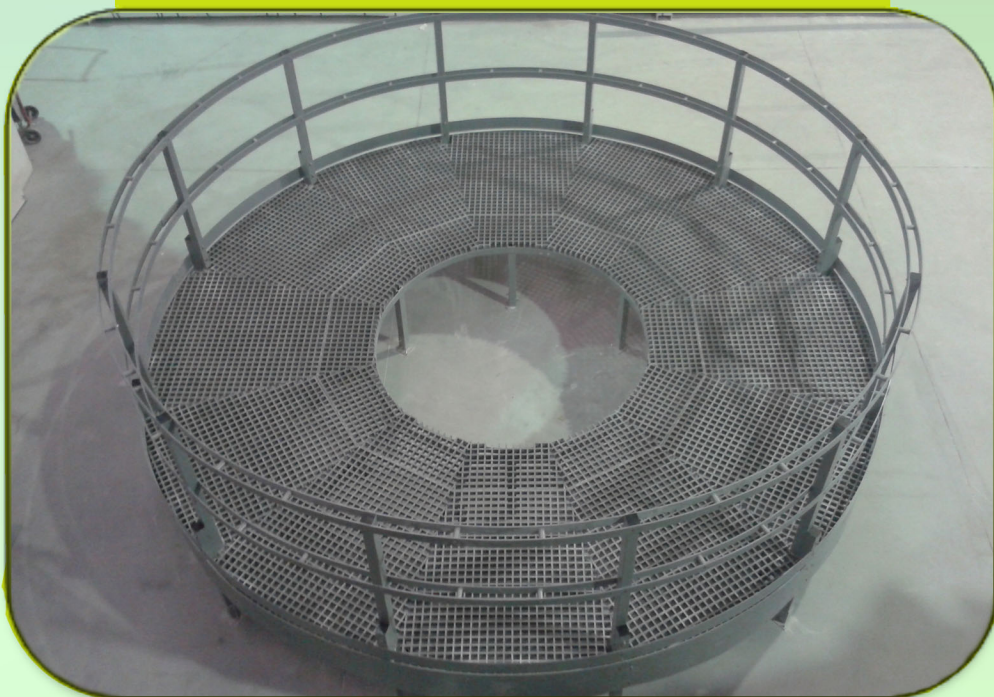

ibérica pultrusionados

Desenho Técnico

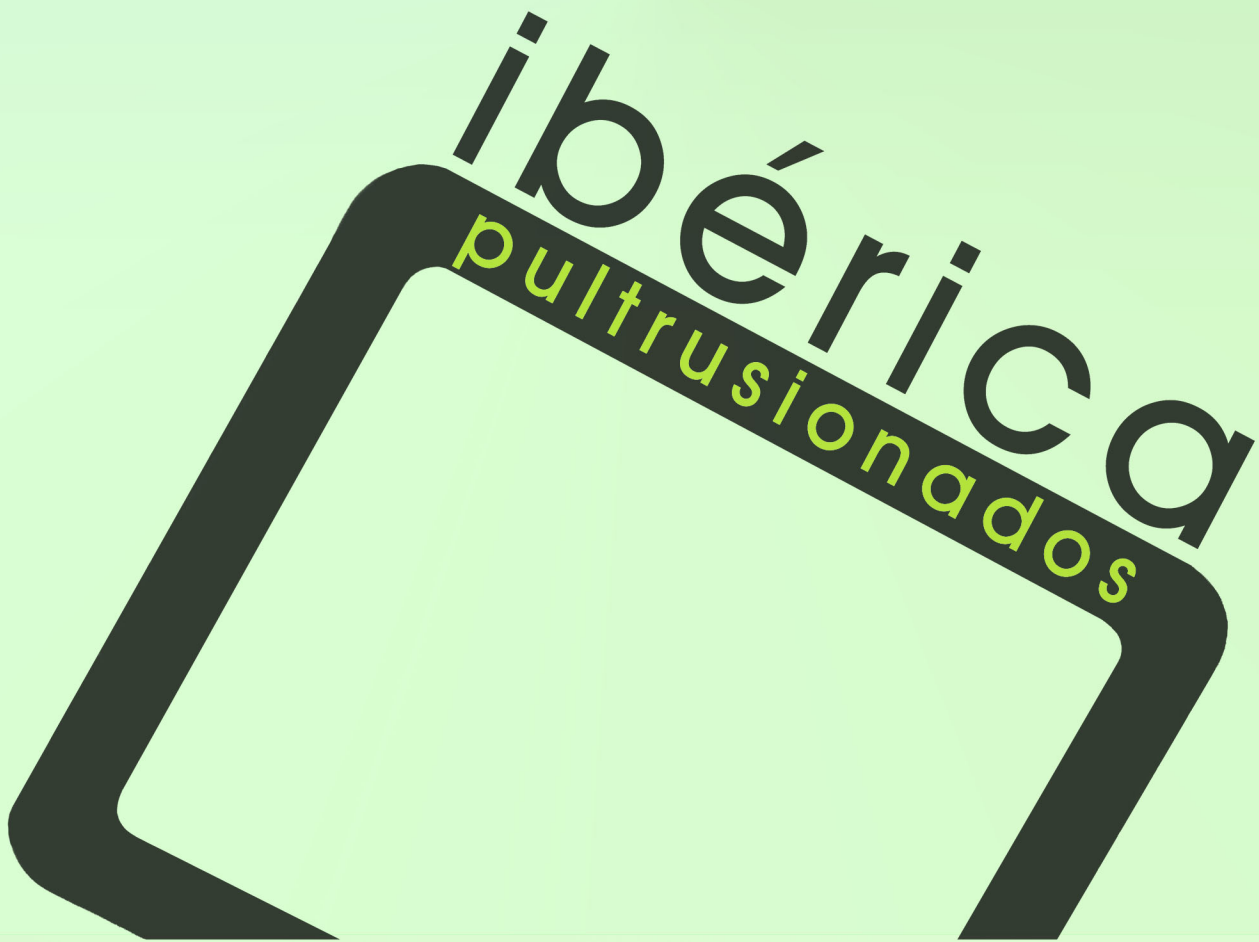

Acessórios e Kits

Dispomos de produção própria dos acessórios de montagem o que possibilita uma rápida execução de projectos especiais.

Encontram-se disponíveis acessórios fabricados em PRFV e aço inoxidável.

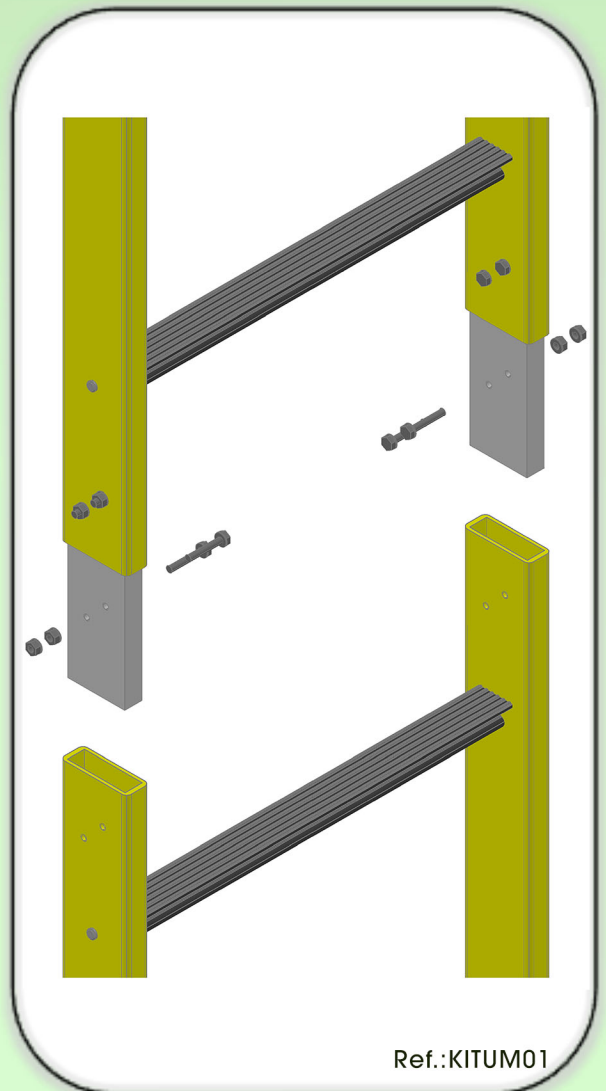
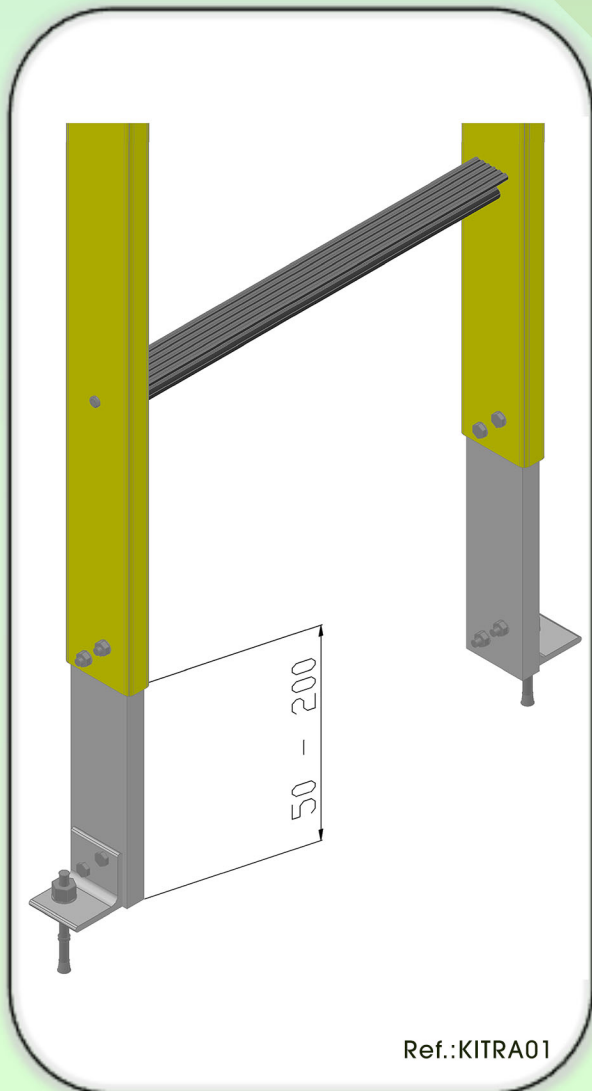
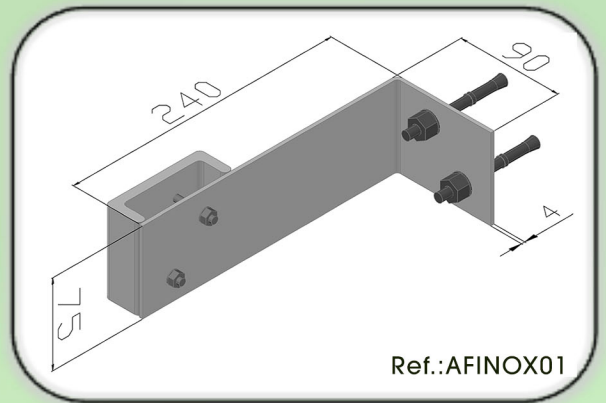
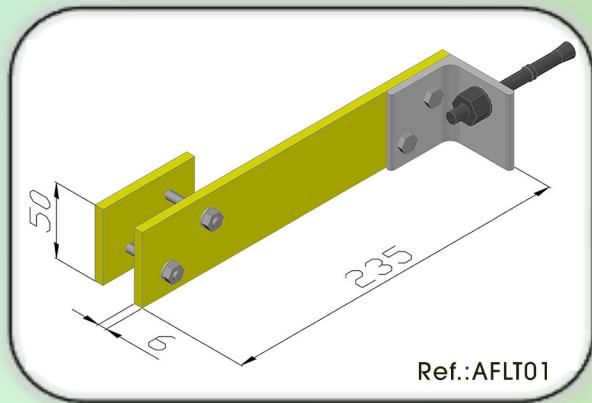

Acessorios e Kits

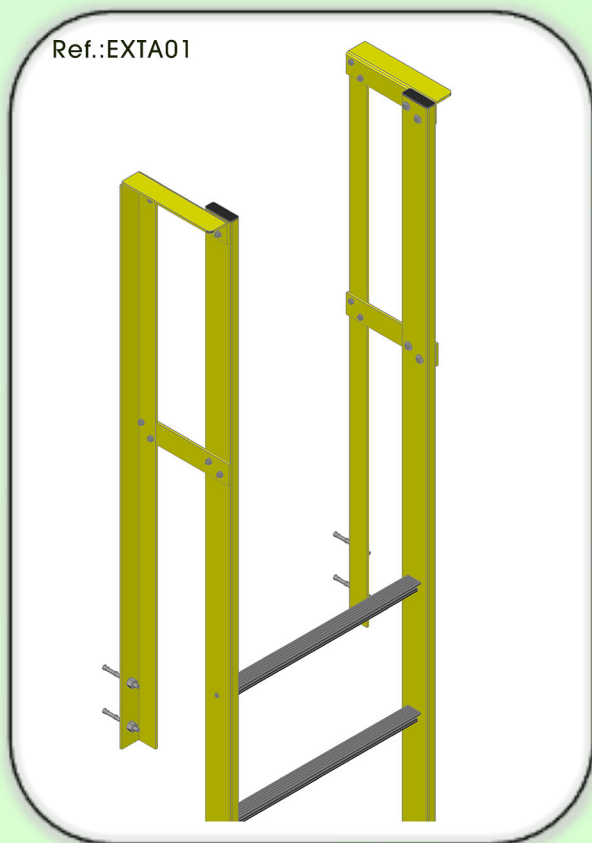
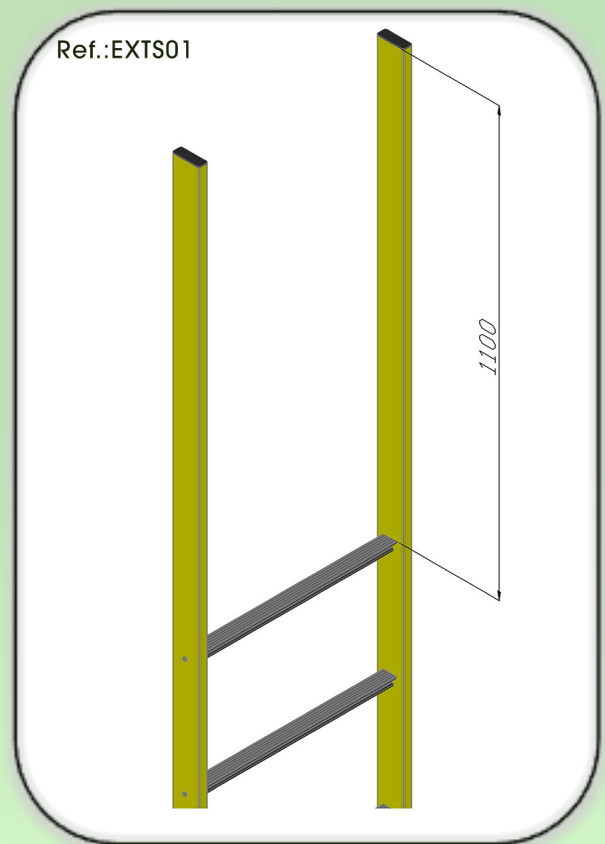
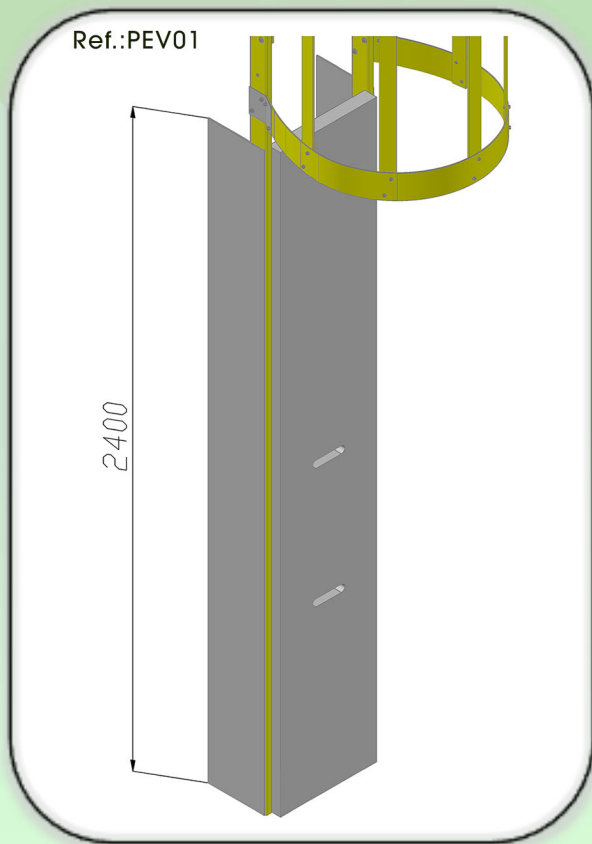

Acessorios e Kits | Escada vertical

Escada vertical modelo EV_IBP_LT: Equipamento desenhado e testado para cumprir as normas ISO 14122-4 e EN131.

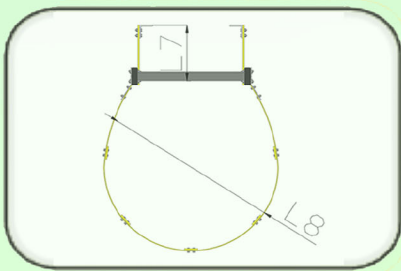
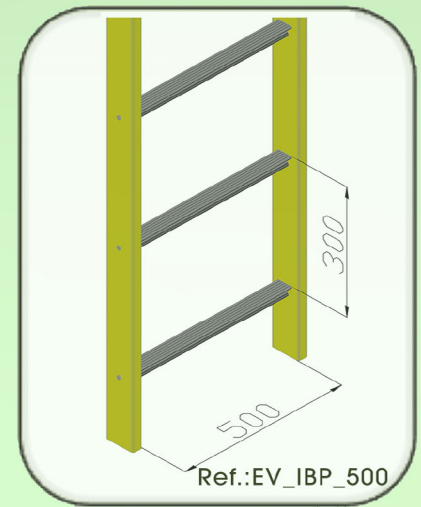
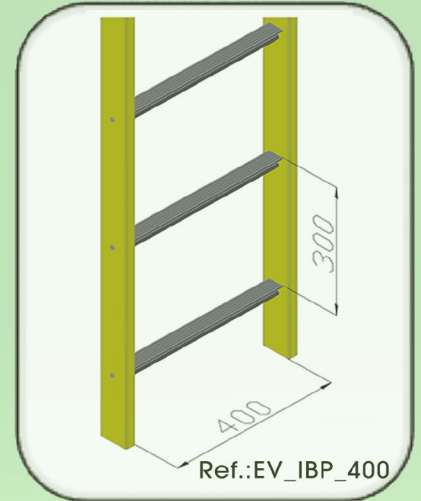
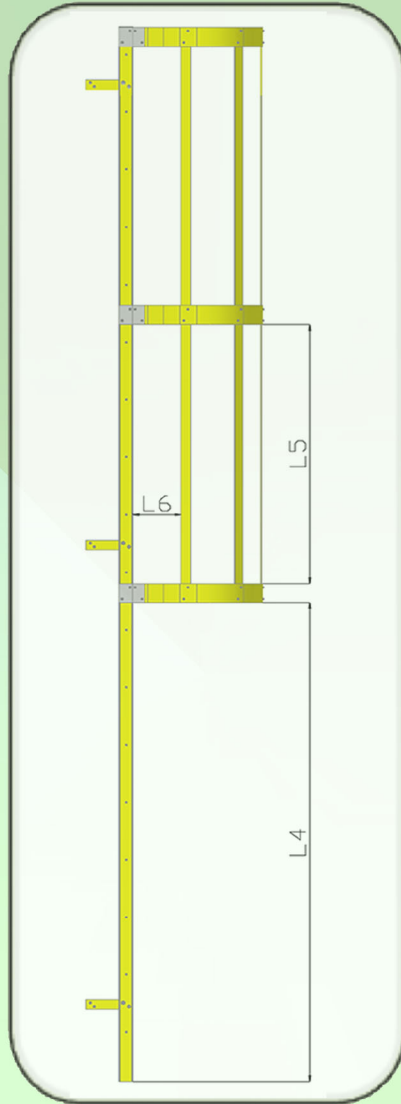
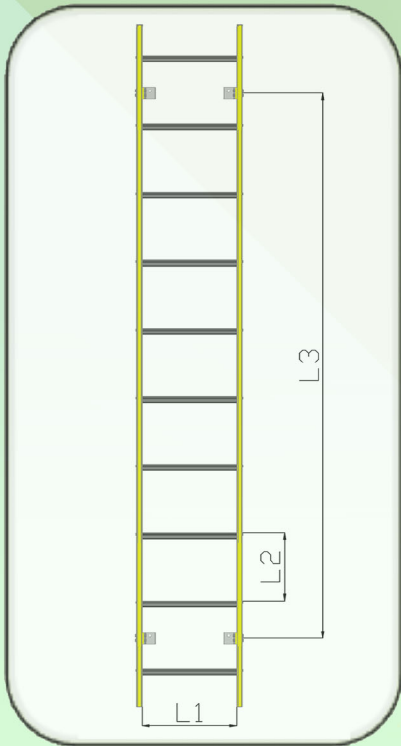

Dim.	Equipamento Standard	Limites da Norma
L 1	400 mm y 500 mm	400 mm → 600 mm
L 2	300 mm	225 mm → 300 mm
L 3	Max = 3000 mm	N / D
L 4	2200 mm → 3000 mm	2200 mm → 3000 mm
L 5	Max = 1500 mm	Max = 1500 mm
L 6	Max = 300 mm	Max = 300 mm
L 7	Min = 200 mm	Min = 200 mm
L 8	650 mm y 750 mm	650 mm → 800 mm

Acessorios e Kits

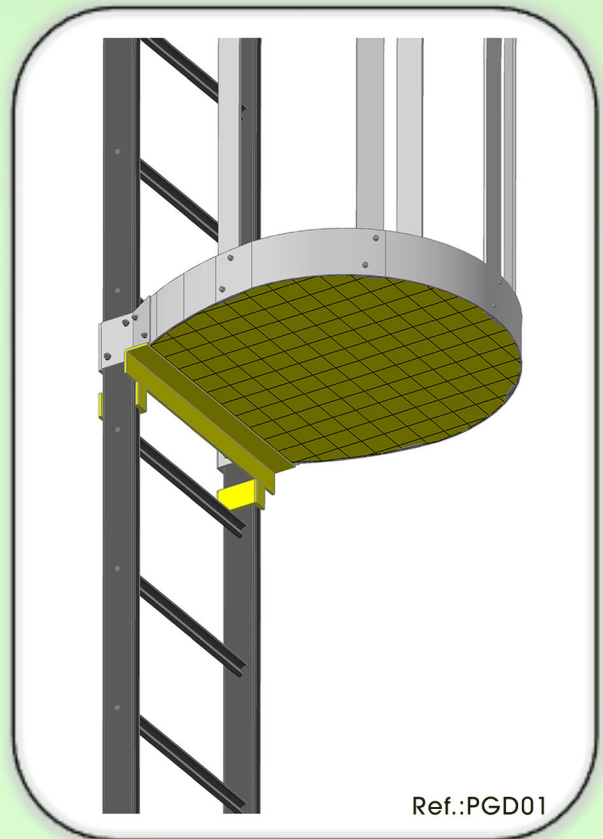
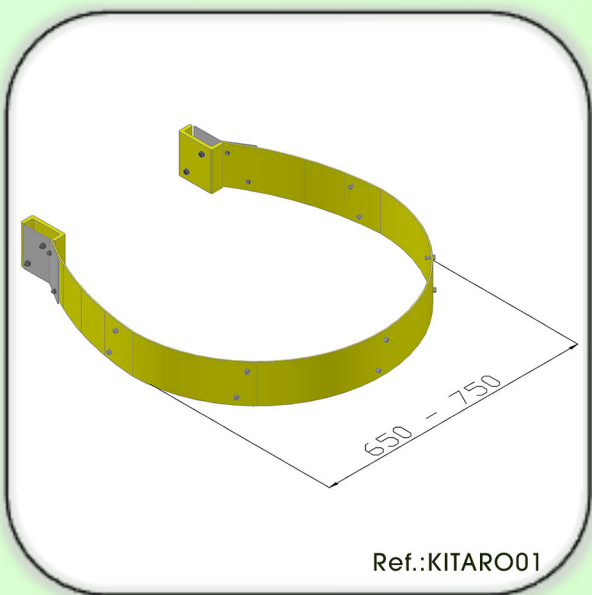
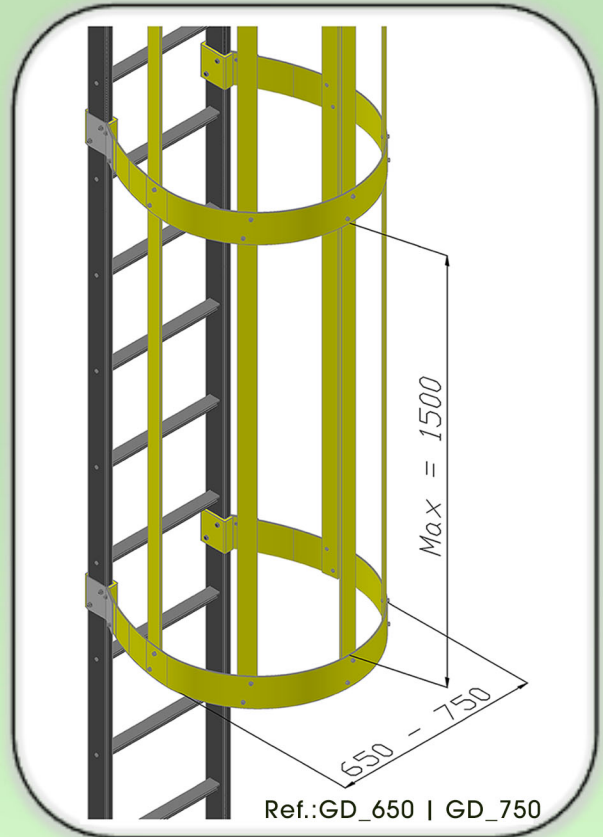

ibérica pultrusionados

